

FastTrack™

Pre-sloped Trench Drain System

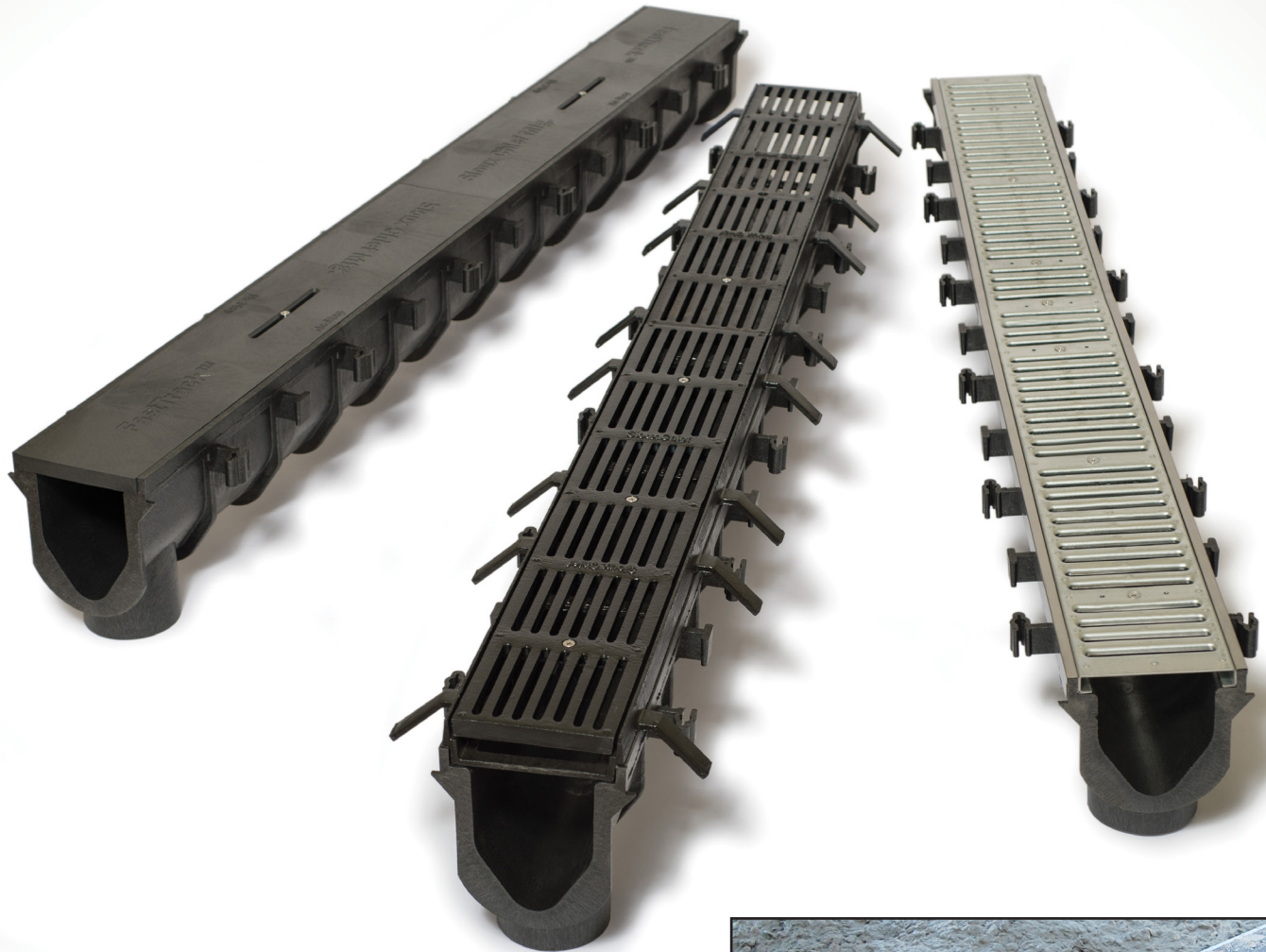

Fast

Construction covers included to protect channels during rough-in. Longer channels for fewer joints. Solid connections for better alignment

Versatile

Sloped and neutral channels made from tough, lightweight, HDPE material.

A variety of grating options for all types of traffic applications. Integral bottom outlets



Supply | Drainage | Support | Specialties

www.siouxchief.com

TAKE THE FIELD.



FastTrack™

» System Features

- Durable construction covers protect channels during rough-in. Keeps concrete and debris out of the drain line
- Channels molded from tough, lightweight, high-density polyethylene are U.V. and chemical resistant
- Longer (72") channels mean fewer joints are needed for the same run length
- Solid channel joints that don't require fasteners
- Grate anchors and structural ribs prevent deformation during the concrete pour
- Convenient, integral bottom outlet included on all channels. End caps and end outlets are also available
- Optional ductile iron frames and a variety of grating for all types of traffic applications

Construction covers (2) are included with all channels

Engineered bottom radius helps increase low-volume flow rate and reduce sediment buildup

Pre-molded 4" No-Hub bottom outlet

End Outlet

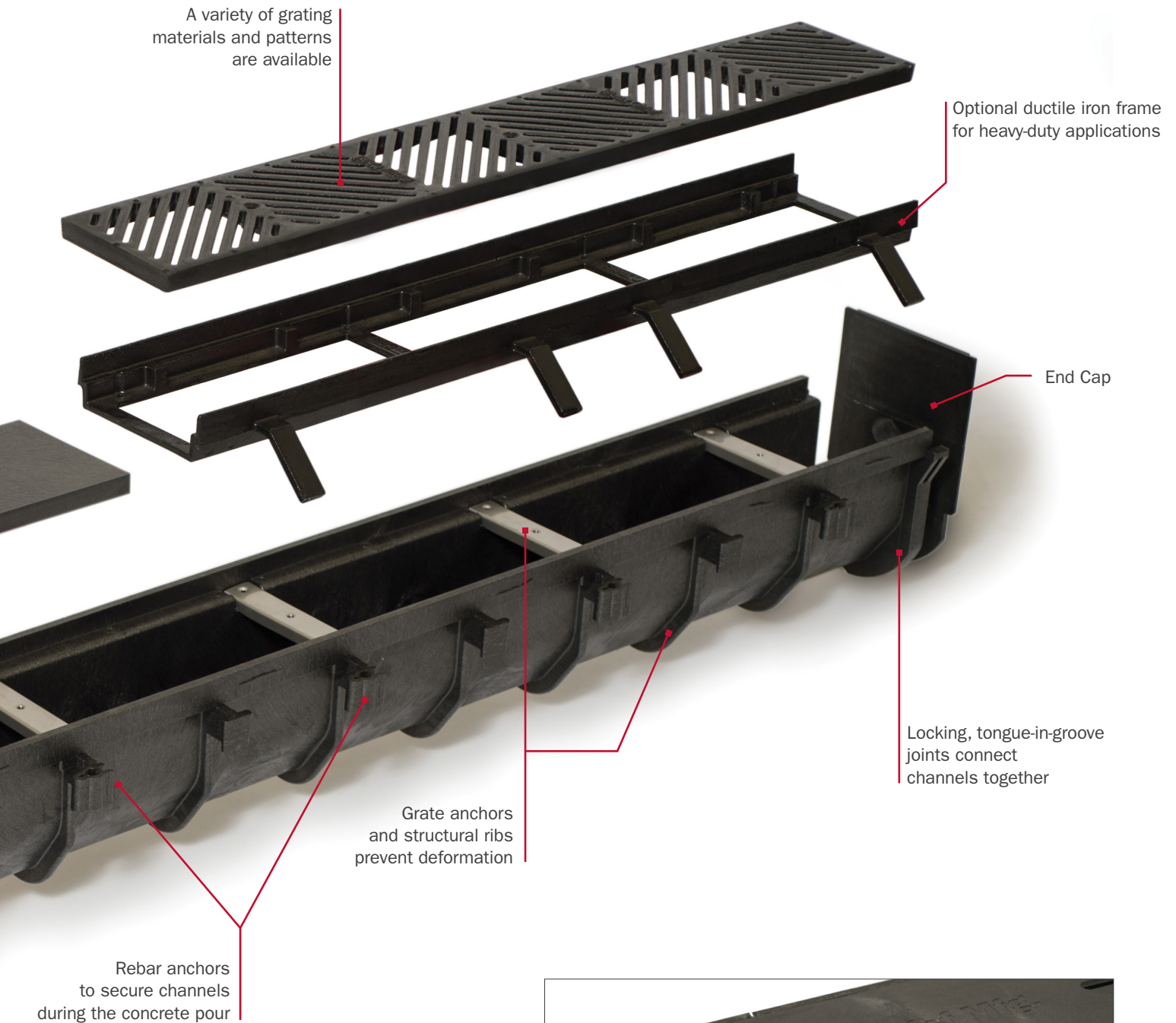

Construction covers can slide across joints to help keep the run straight

Installation Guide

Always consult local codes for specific requirements regarding trench drain installation in your area before beginning.

Always wear protective gear and observe safety precautions when installing the FastTrack™ system.

Plan/Excavate

Excavate a trench for the FastTrack, considering both load class and slab thickness. All channels (and catch basin, if installed) must be encased with concrete on three sides. See *Installation Diagram* (pg 8) for dimensions. The engineer should determine slab thickness based on application and traffic rating.

Concrete encasement is required regardless of surface type (concrete, asphalt, pavers, etc.).

Expansion joints will be needed on each side of the trench, according to specifications. Do Not use the FastTrack as an expansion joint.

Set a string line in the trench at level of final slab elevation to use as a guide.

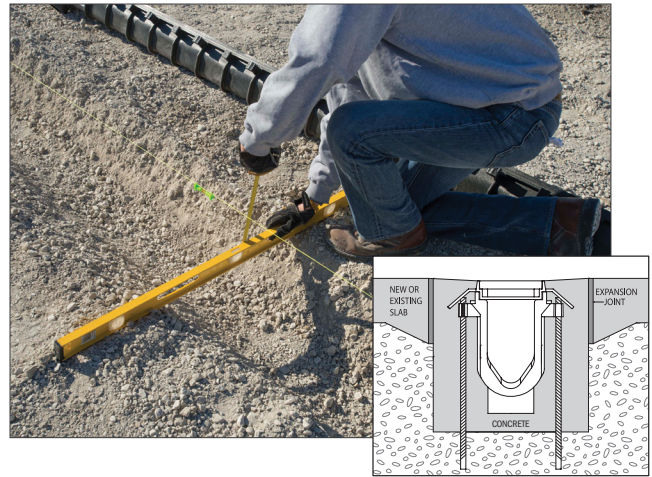

Layout Channels

Lay out the channels, in order, alongside the excavated trench, starting with the deepest point (catch basin or outlet point) and working 'upstream'. Be sure flow arrows point towards the outlet end.

For Catch Basin: Set catch basin in position (checking for elevation, level, and alignment), and anchor securely in place with rebar.

For End Outlet: Open the end outlet fitting using a hole saw. Attach the end outlet with screws to the deep end and the end cap on the shallow end. Be sure to allow for sufficient slab thickness above the outlet and pipe.

For Bottom Outlet: Using a hole saw, open the bottom outlet in the deep end and install end caps on channel ends.



Assemble Channels

Beginning at the outlet end, connect the channels together in order. Silicone sealant can be used in the groove/joint if desired.

If Using Iron Grate Frames or SS Edge Guards: Remove the construction covers and install grate frames or edge guards. Reinstall the construction covers in the frames or guards.

Slide the construction covers (downstream) such that they overlap the joint - this will help prevent misalignment at the joints.



Anchor with Rebar

Beginning at the outlet end, install rebar into the anchor clips on either side of the channel and drive rebar into the ground. Adjust channel, checking for elevation, level, and alignment using the string line as a guide. The top of the channel should be set $\sim 3/16$ " below finish slab level.

When the channel is in proper position, secure the rebar into the anchor clips using screws or tie-wire to lock in place.

Continue the installation with upstream sections, setting with rebar, checking for elevation, level, and alignment until all channel sections are set.



Set with Concrete

Confirm all channels are in final position and anchored with rebar and screws (wire) in ALL available anchor clips to keep the run as secure as possible. Be Sure:

- Channels will be encased in concrete (4" min.)
- Expansion joints will be installed on each side
- Channel is recessed $\sim 3/16$ " below the finish slab

Connect drain piping to the catch basin or channel outlet according to plans. Use a No-Hub coupling to connect to channel outlet, or a connection adapter for the catch basin.

Set concrete "pads" around rebar, under and on sides of the basin/channels to prevent movement or misalignment.

Pour the concrete slab around the installation and vibrate to eliminate voids in the pour.



Final Inspection

After the concrete takes final set (24 hrs. min), remove the construction covers. Inspect the installation to be sure channels and drain piping are free of debris.

Set appropriate grating in place and secure the grates into the grate anchors using screws.



Grate Options



Slotted Ductile Iron

Enamel-coated ductile iron material. Heavy duty applications, forklift and commercial vehicle traffic at less than 15 mph. *Load class D when installed in iron frame only

Cross-Slot Ductile Iron

Enamel-coated ductile iron material with cross-slot pattern. Parking areas and truck traffic at less than 15 mph.

Diagonal-Slot Ductile Iron

Enamel-coated ductile iron material with decorative, diagonal pattern. Parking areas and truck traffic at less than 15 mph.



Slotted Polymer

Corrosion-proof, U.V. protected material is tough, durable and chemical-resistant. For light duty areas, pedestrian traffic, walkways, pool areas, etc.

Slotted Stainless / Galvanized

Corrosion-resistant, 304 stainless steel or G90 galvanized material. For pedestrian, bicycle, and two-wheeled hand carts.

Reinforced Slotted Stainless / Galvanized

Corrosion-resistant, 304 stainless steel or G90 galvanized material. Includes reinforcing rib for parking areas and light vehicle traffic at less than 15 mph.



Perforated Stainless / Galvanized

Corrosion-resistant, 304 stainless steel or G90 galvanized material. For pedestrian traffic, kitchen and food-prep areas.

Stainless Steel Brickslot

Designed for use with brick or paver surfaces. The slot blends perfectly with surrounding surface, and reduces water 'cross-over'.

Diagonal-Slot Stainless Steel

Corrosion-resistant, 304 stainless steel with Decorative, pattern. For pedestrian, bicycle, and hand-cart traffic, kitchen and food-prep areas..

»» Grate Load Classifications

Trench drain grates are tested according to the DIN EN 1433 standard.

Grates are subjected to test loads, which are applied with a 3" x 10" platen.

Class A

Loads up to 3,372 LBS

Pedestrian traffic. Walking areas, bicycles, light, two-wheeled hand carts

Class B

Loads up to 28,101 LBS

Small/private parking areas. Car and light vehicle traffic at less than 15 mph.

Class C

Loads up to 56,202 LBS

Trucks and commercial parking areas. Vehicle traffic at less than 15 mph.

Class D

Loads up to 89,924 LBS

Heavy-duty, forklift and commercial vehicle traffic at less than 15 mph.

Accessories



Catch Basin

In-line catch basin connects seamlessly to channels on one or both ends. Works with any FastTrack channel, and all grate options. Rugged, HDPE basin is available with a removable, heavy-duty, galvanized basket to keep debris out of the drain line. Side cut-out is designed for use with outlet adapters for easy connection to 4" or 6" drain pipe. Includes stainless steel grate anchors (3) and construction cover.

Use 865-CB4 outlet adapter for 4" pipe, or 865-CB6 for 6" pipe (see Buying Info, back page)



End Cap / End Outlet

HDPE end cap or 4" No-Hub outlet connection (open outlet with hole saw). Installs easily with screws, use sealant if desired. Trim excess off top; flush with construction cover prior to slab pour.

When using end outlet, be sure to allow for sufficient slab thickness above the outlet and pipe.



Decorative Edge Guards

Corrosion-resistant, 304 stainless steel edge guards cover channel edges for a more finished look. Works with all grate styles/materials - does not affect load capacity of grate. Edge guards slide over top edge of the channel. Fasten with screws if desired.*

** Edge guards must be installed before concrete is poured.*



Ductile Iron Frame

Enamel-coated ductile iron material. Prevents wear/impact damage to channel edges. Transfers traffic load into the surrounding concrete. Works with all grate styles/materials. Must be used with iron grates for Class D load requirements. Iron frames attach easily to the channel with screws.*

** Frames must be installed before concrete is poured.*



Construction Cover

All channels ship with two construction covers installed as standard.

Durable, U.V. protected cover installs in the channel during rough-in and slab pour. Construction cover protects channels from damage and debris. Covers slide to overlap joints and help maintain alignment. Use with or without iron frame. Replace with grate after slab cures.



Dome Bottom Strainer

Stainless steel perforated strainer installs above bottom outlet to prevent trash, leaves, and other debris from entering the drain pipe. Spring-tabs insert into the outlet and hold strainer in place. Removes easily for cleaning.

Typical Configurations

▄▄▄ Sloping

- FastTrack channels are available pre-sloped (0.75%) or neutral. Systems can be designed using all sloped, all neutral, or can combine both types
- Neutral channels can be used where the ground itself slopes or where excavation depth must be minimized

All Sloped - One Direction 54 ft



Sloped & Neutral - One Direction 78 ft



Neutral / No Slope



▄▄▄ Outlet Type

- FastTrack channels are designed with an integral bottom outlet or attach an end outlet for pipe connection
- Bottom and end outlet size is 4" no-hub - make connection to the pipe with standard no-hub couplings

End Outlet:



Note: When using end outlets, be sure to allow sufficient slab depth above outlet and drain pipe to prevent cracking.

Bottom Outlet:

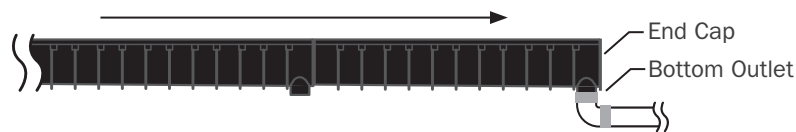

▄▄▄ Cutting

- FastTrack channels and grates can be cut to length with a handsaw or reciprocating saw
- Ribs on the channels are spaced at 6" intervals for quick measurements and allow for easy attachment of the end cap. Always cut end(s) opposite the outlet

Cut Section:

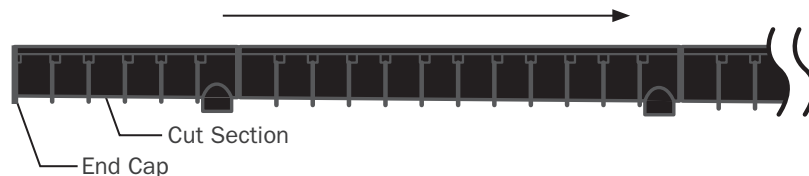

»» Outlet Location

- Connect drain pipe to the FastTrack on the bottom of the channel or to the end
- Systems can be designed to slope to one end, to the center, to both ends or to multiple bottom outlets

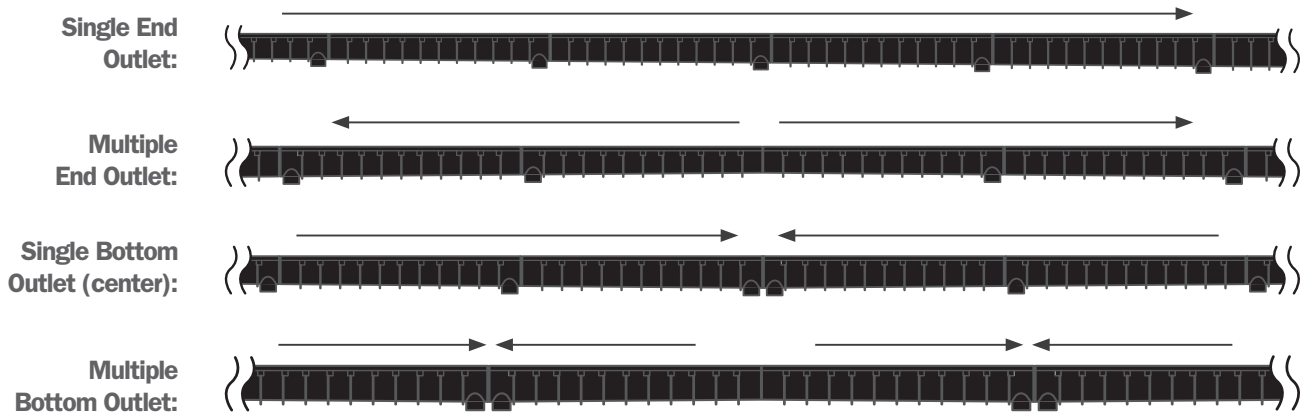

Installation Diagram

- Installation diagram below should be used as a guide only. Always consult local codes for specific requirements regarding trench drain installation in your area before beginning.
- FastTrack systems require full concrete encasement on three sides, regardless of surface material/finish – see table (right) for dimensions.
- Install expansion joints on both sides of, and parallel to the channel, per specifications
- Ductile iron grate frame (shown below) is required for Load Class D. Frame is optional for Load Class A-C

Encasement Dimensions (According to Calculation)	
LOAD CLASS	DIMENSION X
Class A	4" (MIN 4,000 PSI)
Class B	6" (MIN 4,000 PSI)
Class C	6" (MIN 4,000 PSI)
Class D	8" (MIN 4,000 PSI)

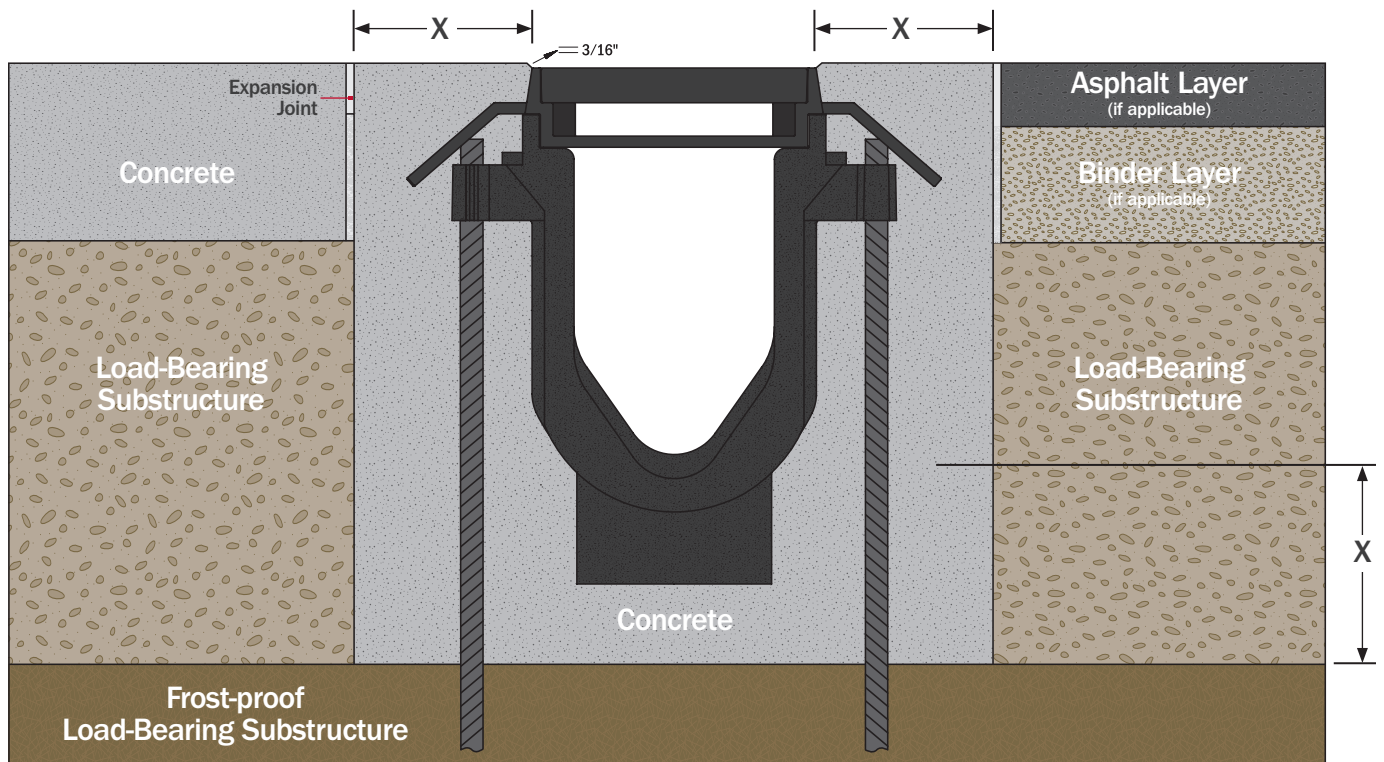

Chemical Resistance Guide

The following should be used for reference only. Many factors affect the chemical resistance of a product. A test under specific conditions should confirm the FastTrack is fully compatible with the application before installation.



Chemical	Max. Temp	Chemical	Max. Temp	Chemical	Max. Temp
Acetic Acid, 60%	70° F	Ethyl Acetate, 100%	NR	Nicotinic Acid	140° F
Acetone	140° F	Ethyl Alcohol	140° F	Nitric Acid, 70%	70° F
Alcohol	140° F	Ethylene Glycol	140° F	Nitrobenzene	NR
Aluminum Chloride	140° F	Ethylene Dichloride	NR	Olive Oil	140° F
Ammonia	70° F	Fluosilicic Acid	140° F	Oxalic Acid	140° F
Ammonium Hydroxide	NR	Formaldehyde, 30%	140° F	Paraffin Oil	70° F
Battery Acid	140° F	Fructose	140° F	Phenol	140° F
Beer	140° F	Fuel Oil	140° F	Phosphoric Acid, 90%	140° F
Benzene	NR	Gallic Acid	140° F	Pine Oil	NR
Borax	140° F	Gasoline	70° F	Potassium Bromide	140° F
Boric Acid	140° F	Glucose	140° F	Potassium Nitrate	140° F
Brake Fluid	140° F	Glycerin	140° F	Potassium Perchlorate, 10%	140° F
Brine	140° F	Glycolic Acid, 30%	140° F	Potassium Sulfate	140° F
Bromic Acid, 10%	140° F	Heptane	NR	Propyl Alcohol	140° F
Calcium Carbide	140° F	Hexane	NR	Propylene Glycol	140° F
Calcium Chloride	140° F	Hydraulic Fluid	70° F	Salicylic Acid	140° F
Calcium Hypochlorite	140° F	Hydrobromic Acid, 50%	140° F	Sodium Carbonate	140° F
Carbon Tetrachloride	NR	Hydrochloric Acid, 35%	140° F	Sodium Hydroxide	140° F
Carbonic Acid	140° F	Hydrofluoric Acid, 75%	140° F	Sodium Hypochlorite	140° F
Castor Oil	140° F	Hydrogen Peroxide, 30%	70° F	Sodium Nitrate, 50%	140° F
Caustic Soda	70° F	Isobutyl Alcohol	140° F	Soybean Oil	140° F
Chlorine Liquid	NR	Isopropyl Alcohol	140° F	Sulfuric Acid, 50%	140° F
Chlorobenzene	NR	Jet Fuel	140° F	Sulfuric Acid, 70%	70° F
Chloroform	NR	Kerosene	70° F	Tannic Acid, 10%	140° F
Citrus Juices	140° F	Lactic Acid, 90%	140° F	Toluene	NR
Coffee	140° F	Lard	140	Transformer Oil	70° F
Corn Oil	140° F	Lemon Oil	NR	Trichloroethylene	NR
Cotton Seed Oil	140° F	Machine Oil	70° F	Turpentine	NR
Detergents (synthetic)	140° F	Methyl Ethyl Ketone	NR	Urine	140° F
Dibutyl Ether	NR	Methanol	70° F	Vinegar	140° F
Dichloroethane	NR	Methyl Alcohol	70° F	Water, Distilled	140° F
Diethylene Glycol	140° F	Milk	140° F	Whiskey / Wine	140° F
Disodium Phosphate	140° F	Mineral Oils	140° F	Xylene	NR
Emulsions, Photographic	140° F	Naphtha	NR	Zinc Oxide	140° F
Ethanol, 96%	140° F	Naphthalene	70° F	Zinc Sulfate	140° F

System Specs

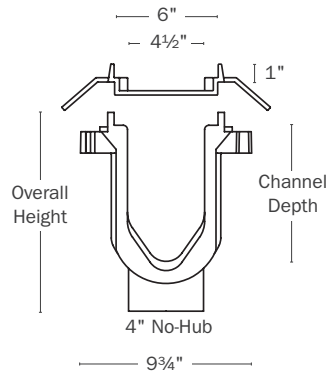

System Notes

- The FastTrack system is designed for on-grade installations only
- Using neutral channels will affect the overall slope of the system and the estimated flow rate
- Always install expansion joints on both sides of, and parallel to the channel, per specifications
- Finished grate level should be ~3/16" below finished slab level and slab should be sloped toward the channel on both sides to promote proper drainage

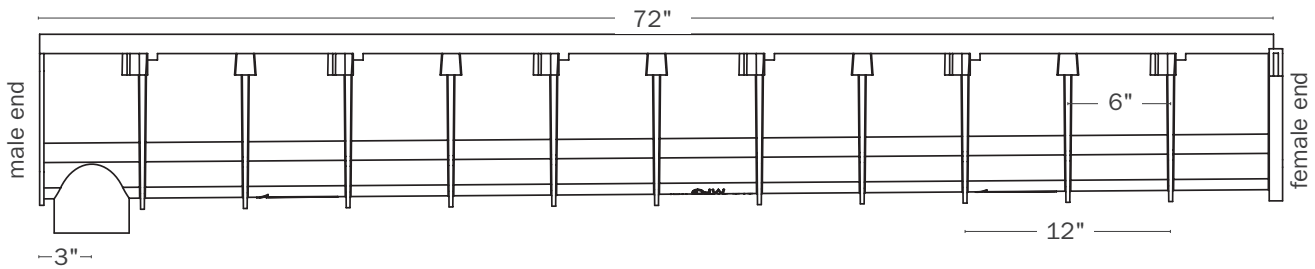

Channel	Channel Depth		Overall Height ¹	Slope Type	Weight ² Lbs.	Est. Flow Rate ³	
	Shallow End	Deep End				GPM	CFS
865-S1	3.62"	4.16"	7.28"	Sloped (0.75%)	15.4	91.23	0.20
865-S2	4.16"	4.70"	7.82"	Sloped (0.75%)	16.4	119.13	0.27
865-N3	4.70"	4.70"	7.82"	Neutral	16.9	—	—
865-S3	4.70"	5.24"	8.35"	Sloped (0.75%)	17.4	147.79	0.33
865-S4	5.24"	5.78"	8.90"	Sloped (0.75%)	18.4	176.97	0.39
865-N5	5.78"	5.78"	8.90"	Neutral	18.9	—	—
865-S5	5.78"	6.32"	9.44"	Sloped (0.75%)	19.4	206.55	0.46
865-S6	6.32"	6.86"	9.98"	Sloped (0.75%)	20.4	236.42	0.53
865-N7	6.86"	6.86"	9.98"	Neutral	20.9	—	—
865-S7	6.86"	7.40"	10.52"	Sloped (0.75%)	21.4	266.52	0.59
865-S8	7.40"	7.94"	11.06"	Sloped (0.75%)	21.4	296.81	0.66
865-N9	7.94"	7.94"	11.06"	Neutral	21.9	—	—
865-S9	7.94"	8.48"	11.60"	Sloped (0.75%)	22.4	327.23	0.73

1 Add 1" to overall height when using iron frame

2 Weight includes grate anchors and construction covers

3 Estimated flow rate is for the single channel only (open ends, no grate), and is based on calculation using Manning's equation



865-S1



865-GIS



865-F



865-FC

» Buying Information

ITEM NO.	DESCRIPTION	MIN. QTY.	CASE QTY.
CHANNELS			
865-S1	Sloped Channel Section with Construction Cover - 72" Long	1	1
865-S2	Sloped Channel Section with Construction Cover - 72" Long	1	1
865-N3	Neutral Channel Section with Construction Cover - 72" Long	1	1
865-S3	Sloped Channel Section with Construction Cover - 72" Long	1	1
865-S4	Sloped Channel Section with Construction Cover - 72" Long	1	1
865-N5	Neutral Channel Section with Construction Cover - 72" Long	1	1
865-S5	Sloped Channel Section with Construction Cover - 72" Long	1	1
865-S6	Sloped Channel Section with Construction Cover - 72" Long	1	1
865-N7	Neutral Channel Section with Construction Cover - 72" Long	1	1
865-S7	Sloped Channel Section with Construction Cover - 72" Long	1	1
865-S8	Sloped Channel Section with Construction Cover - 72" Long	1	1
865-N9	Neutral Channel Section with Construction Cover - 72" Long	1	1
865-S9	Sloped Channel Section with Construction Cover - 72" Long	1	1
GRATES			
865-GiS	Slotted Ductile Iron Grate with Screws - 36" Long - Class D ¹	1	1
865-GiC	Cross-Slot Ductile Iron Grate with Screws - 36" Long - Class C	1	1
865-GiD	Diagonal-Slot Ductile Iron Grate with Screws - 36" Long - Class C	1	1
865-GHS	Slotted HDPE Grate with Screws - 36" Long - Class A	1	1
865-GHC	Cross-Slot GF Polypro Grate with Screws - 36" Long - Class A	1	1
865-GSA	Angle-Slot Stainless Steel Grate with Screws - 36" Long - Class A	1	1
865-GSB	Stainless Steel Brick Slot Grate with Screws - 36" Long - Class C	1	1
865-GSBC	Stainless Steel Brick Slot Access Section (for use with 865-GSB) - 12" Long - Class C	1	1
865-GSD	Perforated Stainless Steel Grate with Screws - 36" Long - Class A	1	1
865-GSS	Slotted Stainless Steel Grate with Screws - 36" Long - Class A	1	1
865-GSSR	Reinforced Slotted Stainless Steel Grate with Screws - 36" Long - Class C	1	1
865-GGD	Perforated Galvanized Steel Grate with Screws - 36" Long - Class A	1	1
865-GGS	Slotted Galvanized Steel Grate with Screws - 36" Long - Class A	1	1
865-GGSR	Reinforced Slotted Galvanized Steel Grate with Screws - 36" Long - Class C	1	1
ACCESSORIES			
865-A	Grate Anchor - Stainless steel - Fits All Channels	1	20
865-C	Construction Cover - HDPE 36" Long - Fits All Channels	1	1
865-CB4	4" Outlet Adapter for Catch Basin - Fits 3" & 4" Sch. 40, 4" SDR35 Pipe	1	1
865-CB6	6" Outlet Adapter for Catch Basin - Fits 6" SDR35 Pipe	1	1
865-D	Dome Strainer for Channel Bottom Outle - Stainless steel - Fits All Channels	1	1
865-EC	End Cap - HDPE Flat Cap – Fits All Channels	1	50
865-EG	Edge Guards - Stainless steel - 36" Long - Pair with Screws - Fits All Channels ³	1	1
865-EO	End Outlet - HDPE with 4" No-Hub Connection ² - Fits All Channels	1	25
865-F	Ductile Iron Grate Frame - 36" Long with Screws - Fits All Channels	1	1
865-FB	Debris Basket for Catch Basin - Galvanized Steel with Handle	1	1
865-FC	In-Line Catch Basin - 36" Long with Construction Cover - Fits All Channels	1	1
865-FCB	In-Line Catch Basin - 36" Long with Debris Basket & Construction Cover - Fits All Channels	1	1
865-S15	Screws for FastTrack Grates - 1/4-20 x 1-1/2" - Bag of 3	1	100

1 Class D load rating requires use of 865-F grate frame | 2 Be sure to allow for sufficient slab thickness above the outlet and pipe | 3 Not for use with 865-F grate frame